

LED STADIUM LIGHT



By Installing LED Stadium lighting you will save on your energy bills and reduce costs. XTREME LED Stadium Light is a professional high power sports lighting fixture. They are simply the best and extreme performer in the market.

- ✓ Green & Eco-friendly, no mercury
- ✓ Input Voltage 220-240 VAC
- ✓ Energy saving, long lifespan
- ✓ No UV or IR in the beam
- ✓ Easy to install and operate
- ✓ Instant start, NO Flickering

174000
LUMENS

5 YEAR
PRODUCT
WARRANTY

145lm/w

MARKET LEADING PERFORMANCE

DIMENSIONS

Mounting Brackets:

FM - 482*577*571 MM

AM - 621*577*521 MM

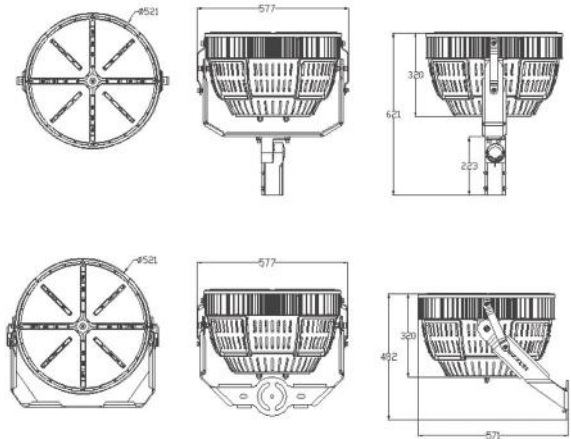

SPECIFICATIONS	SL400W	SL500W	SL600W	SL750W	SL1000W	SL1200W
Wattage	400W	500W	600W	750W	1000W	1200W
Lumens Output	60000-72500LM	60000-72500LM	72000-90000LM	90000-109000LM	120000-145000LM	144000-174000LM
Lumen Efficacy	120-145 LM/W	120-145 LM/W	120-145 LM/W	120-145 LM/W	120-145 LM/W	120-145 LM/W
Beam Angle (50%)	30°	30°	40°	40°	40°	40°
EPA	1.49ft ²	1.49ft ²	2.5ft ²	2.5ft ²	3.14ft ²	3.14ft ²
LED Brand	SEOUL					
LED Type	SMD 3030					
Waterproof Rating	IP65					
PF	>0.9					
Color Temperature	4000-5700 K					
Input Voltage	220-240Vac 50/60Hz					
CRI	>70					
Housing	Aluminium					
Housing Color	Black /Brown White/Customized					
Storage Temperature	-40 °C TO 80 °C					
Safety Certification	UL cUL DLC CE ROHS					
Warranty Time	5 Years					

LIGHT DISTRIBUTION TESTING PARAMMETERS

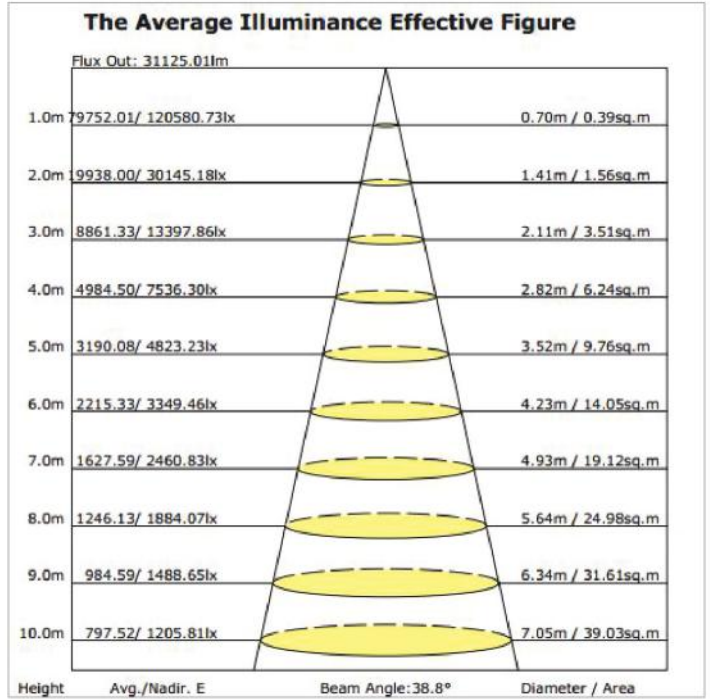
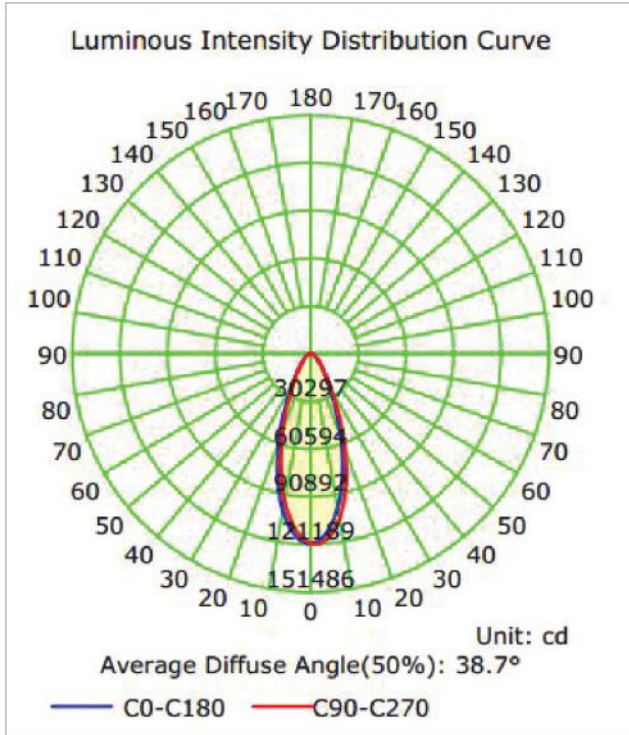

PACKAGE

Lamp Net Weight: 35.2 KG / PC

Lamp Type	Carton Size	Qty / Carton	Gross Weight / Carton
Outer Box	680*630*585 mm	1PC	40.0 KG

